



BREACHING

MEMBER OF SKYLOTEC

BREACHING TOOLS & TRAINING EQUIPMENT

A COMPLETE LINE TO ENSURE YOUR TEAM'S EFFECTIVENESS

MILITARY

LAW ENFORCEMENT

FIRE & RESCUE

SPRING
2025

EQUIPMENT • KNOWLEDGE
TRAINING • SUPPORT

SETBREACHING.COM



SWEDEN ENTRY TOOLS & BREACHING COURSES	3
HEAVY BREACHING KIT STANDARD	4-5
LIGHT BREACHING KIT	6
TACTICAL KIT MOE-140	7
P3 MINIPRY	8
SP3 BREACHING KIT	9
SP4 COMPACT TOOL	10-11
DOOR SLING	12
BREACHING KITS - FIRE & RESCUE	14-15
BREACHING TOOLS	16-21
BOLT CUTTER/SLEDGEHAMMER	21
TACTICAL LADDER	22-23
GLASS BREAKING TOOLS	24-25
TRAINING EQUIPMENT	26-35
BREACHING RIG	36-37



COMPLETE LINE OF BREACHING TOOLS AND TRAINING EQUIPMENT TO ENSURE YOUR TEAM'S EFFECTIVENESS

The construction industry is evolving, consistently striving to develop stronger more secure buildings and materials to provide improved security and safety from crime, fire and natural disaster. These developments however can present a challenge to military and emergency services when they must enter by force.

At Sweden Entry Tools (SET) we are committed to meeting and overcoming the challenge that these developments present to you when failure to enter is not an option. Our combined years of operational police experience has taught us that the right equipment together with the right training will provide the best chance of success. Our breaching tools and equipment combined with our knowledge and techniques prepare you for real situations. The SET breaching courses can be adapted and tailored to meet your specific requirements to develop and enhance your breaching skills.

We can provide:

- 1 Day End User Course
- 2 Days Standard Instructor Course
- 3 Days Advanced Instructor Course
- Custom Breaching Training, please reach out to us for more information

Our instructors have a broad range of operational experience and have been selected for their ability to deliver exceptionally thorough and comprehensive training. SET recognize that different countries are presented with different challenges in door and window breaching. It is for this reason that we take great care in thoroughly researching and customizing the training according to your needs and requirements. For more information please visit www.setbreaching.com

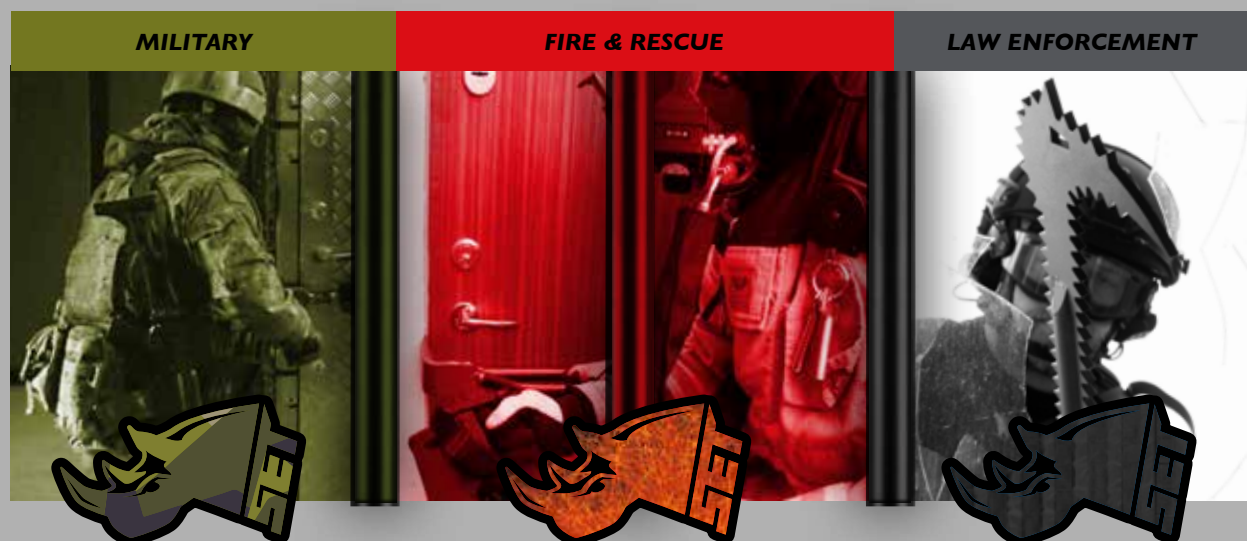

**WE DO NOT JUST SELL BREACHING TOOLS -
WE OFFER YOU KNOWLEDGE AND EXPERIENCE**

LAW ENFORCEMENT AND MILITARY



**FIELD TESTED FOR YEARS BY SOME OF THE
BEST ENTRY TEAMS IN THE WORLD.**

Heavy Breaching Kit Standard



- The Heavy Kit provides a complete set of tools required for more demanding challenges. Carefully selected to deliver maximum performance, these tools can handle both inward and outward-opening doors.
- The larger tools are ideal for high-power tasks, while smaller tools offer precision for lighter work. This kit is tested and proven on material ranging from basic wood or PVC doors to advanced metal security doors.
- Designed for those who want to be prepared for any situation, the Heavy Kit ensures you're equipped to handle a wide range of breaching challenges.
- Available in Dark Grey or Ranger Green.

• Prod Nr: MOE-033-RG • Weight: 22 kg (25 kg incl. Edgebender 2)



WE DO NOT JUST SELL BREACHING TOOLS – WE OFFER YOU KNOWLEDGE AND EXPERIENCE

Light Breaching Kit

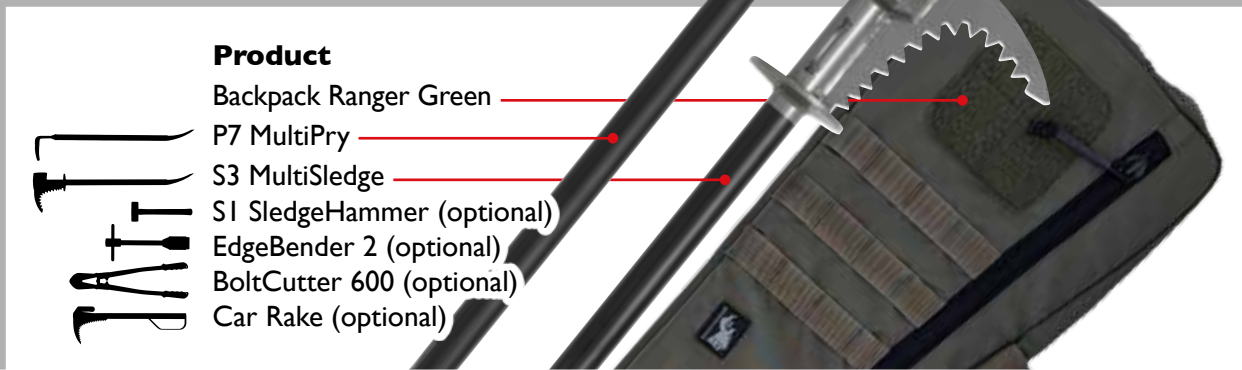

Product

- Backpack Ranger Green
- P7 MultiPry
- S3 MultiSledge
- S1 SledgeHammer (optional)
- EdgeBender 2 (optional)
- BoltCutter 600 (optional)
- Car Rake (optional)

The Light Kit is a versatile, lightweight solution designed for patrol cars, emergency services, and military units.

- The standard version includes our P7 MultiPry and S3 MultiSledge, which together provide the capability to breach both inward and outward-opening doors. This system is proven effective on certified security doors.
- The S3 MultiSledge also allows for the breaching of various types of windows, including laminated glass.
- Available in Dark Grey or Ranger Green

- Prod Nr: MOE-002-RG Light Breaching Kit – ranger green
- Prod Nr: MOE-002-DG Light Breaching Kit – dark grey

• Weight: 6.7 kg

SWEDISH STEEL by SSAB 



Zip pocket ensures secure carriage of equipment on approach, reducing risk of compromise, whilst allowing immediate access by the carrier on target.



Side pocket provides carriage of additional equipment such as S1 SledgeHammer, EdgeBender 2, BoltCutter or Car Rake.



Shoulder and hand portable. Light weight and low profile allowing for discreet or covert approach to target.



Adjustable, balanced and padded shoulder strap provides comfort and hands free carriage. All equipment remains accessible whilst enabling carrier to perform other roles.

Tactical Kit MOE-140



- Created for those who need to reduce the weight and size of their equipment but still want a good breaching ability.
- This kit comes with a backpack solution that makes it possible to carry the tools on your back, without any ends sticking out and risking to damage something or someone.
- Together, P5 and S2 create a system that handles both inward and outward opening doors, ranging from simple plastic doors up to fire doors/metal doors.
- The bag is available in Ranger Green or Dark Grey.

- Prod Nr: MOE-140
- Dimensions: 570 mm x 220 mm x 130 mm
- Weight: 6.7 kg



P3 Mini Breaching Kit



Black

**P3 Mini Breaching Kit
contains two P3 MiniPry.**

- Prod Nr: MOE-080-BL (black)
- Length: 320 mm • Weight: 0.7kg + 0.7kg



Green

**P3 Mini Breaching Kit
contains two P3 MiniPry.**

- Prod Nr: MOE-080-GR (green)
- Length: 320 mm • Weight: 0.7kg + 0.7kg

- The P3 Mini Breaching Kit combines compact tools with our innovative techniques to deliver significant force. It enables swift breaching of simple inward and outward-opening doors.
- In critical situations, one tool function as a sledgehammer, while the other acts as a pry tool. For discreet operations, these tools can be used together to silently separate locks.
- Compact and easy to carry, this kit is ideal for interior doors or as a backup solution for other breaching tasks.

ACCESSORIES

P3 Waist Bag



- Waist bag for different operations, including undercover missions. Color: black

• Prod Nr: MOE-027

P3 Tactical Holster



- Tactical holster with molle system.

• Prod Nr: MOE-025 (green)
MOE-026 (black)

USING THE TOOL



Prying of both out and inward going doors.



With two P3 MiniPry working as a couple, you will get a very effective and small breaching kit.



Silent entry of both out and inward going doors when circumstances allows.

SP3 Compact Tool

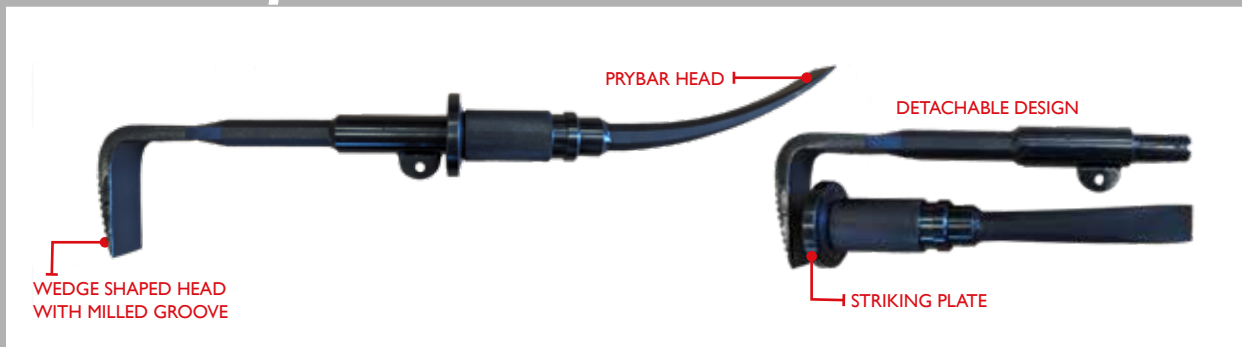

- The SP3 is our smallest breaching tool, designed with the same functionality as our larger models but in a more compact format. This tool allows you to breach both inward and outward-opening doors of a simpler construction. It is the perfect solution for those seeking a lightweight and easily portable system. The SP3 is ideal for breaching interior doors, making it a discreet option for bodyguards or rescue and evacuation scenarios.

• Prod Nr: MOE-065 • Length detached: 235 + 215mm Length attached: 410mm • Weight (total tool): 1.1 kg

USING THE TOOL



Silent entry is an option when circumstances allows.



Use the striking plate as a hammer on outward going doors for quick entry.



Work with the tool detached to optimize your conditions before you breach.



Quick connection between short and full lengths for maximum power.

ACCESSORIES



Waist bag for SP3. Black.
Prod Nr: MOE-028



SP4 COMPACT TOOL

SWEDISH STEEL by SSAB

Prod Nr MOE-003

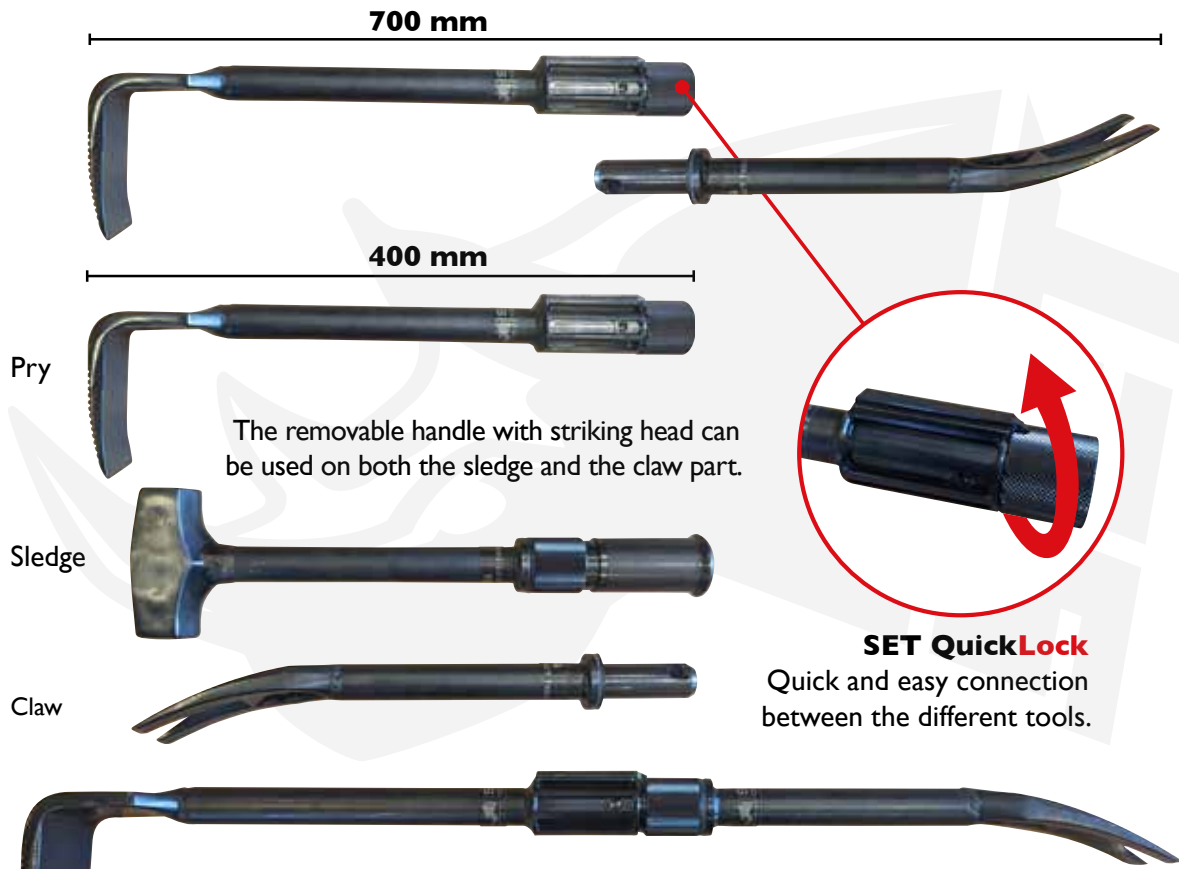

Light and versatile

The SP4 Compact Tool is unique in its form and function. This light and versatile breaching kit allows the operator to optimize the tool for inward or outward going doors in just a few seconds.

• Prod Nr: MOE-003 • Weight Pry: 1.91kg, Sledge: 1.76kg, Claw: 0.94kg Total: 4.61kg (10.1 pound)



CARRYING SYSTEM FOR SP4 COMPACT TOOLS

HOLSTER FOR SP4 COMPACT TOOL

Prod Nr
MOE-004



Individual holsters with molle system

The complete holster can be carried in 2 different ways.

1. As a leg holster with adjustable shoulder sling to balance the weight from the belt.
2. As a back pack with fast connection buckles.

• Prod Nr: MOE-004 • Weight: 0.73 kg



Belt adapter for SP4 Compact Tool
Prod Nr: MOE-020



2 point sling in ranger green. Sold separately.
Prod Nr: MOE-077

BAG FOR SP4 COMPACT TOOL

Prod Nr
MOE-019



The bag for the SP4 Compact tool is designed for “undercover” operation when the breaching equipment needs to be hidden. The bag can be used like a sling bag, backpack or as a insert in a normal back pack.

• Prod Nr: MOE-019 • Length: 470 mm • Width: 200 mm • Height: 85 mm • Weight: 0.57 kg

Door Sling MOE-029

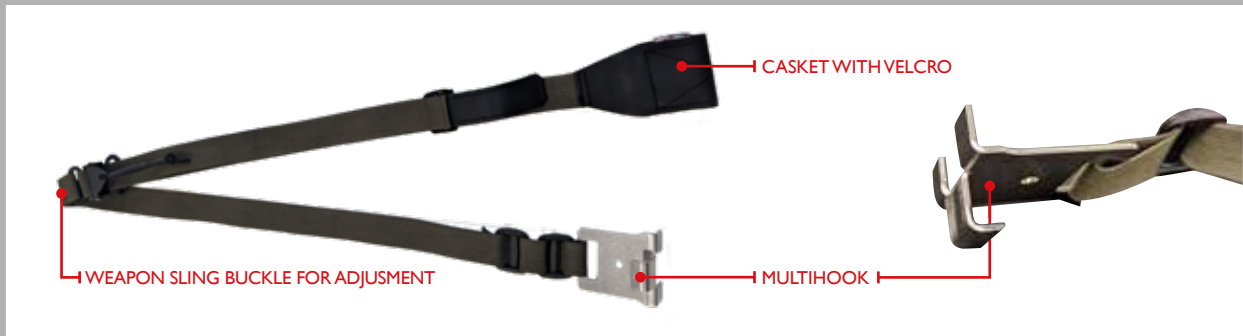

- Made to isolate barricaded suspects, blocking doors when clearing buildings etc or to keep the user safe by preventing doors from opening behind you while conducting a search warrant or similar.
- The Door Sling provides the possibility to block in or outward going doors. Attach the multihook and place the casket around the door handle. Tight it firmly.
- Attach adhesive velcro on the door handle to prevent it from slipping.
- If the frame is weak it's possible to reinforce the hook with a screw.
- The small design allows the operator to carry one or more in small pockets.

• Prod Nr: MOE-029 • Length: 76-148 mm • Weight: 135 g

Information



The multihook can be attached on the eventual overlap on top of the door.



Can be placed in the gap between the door and the frame.



Can also be placed on top of the frame.



**WE DO NOT JUST SELL BREACHING TOOLS -
WE OFFER YOU KNOWLEDGE AND EXPERIENCE**

FIRE & RESCUE

**Complete Breaching Solution for
Fire Departments and Rescue Squads**



All tools except the MiniRam are carried in the bag. With our simple 2 point sling it is easy to carry the MiniRam on one shoulder and the bag on the other for optimal weight distribution.

2 point Sling, Prod Nr: MOE-077

**WE DO NOT JUST
SELL BREACHING
TOOLS - WE OFFER
YOU KNOWLEDGE
AND EXPERIENCE.**

Firefighter Kit

SWEDISH STEEL by SSAB 

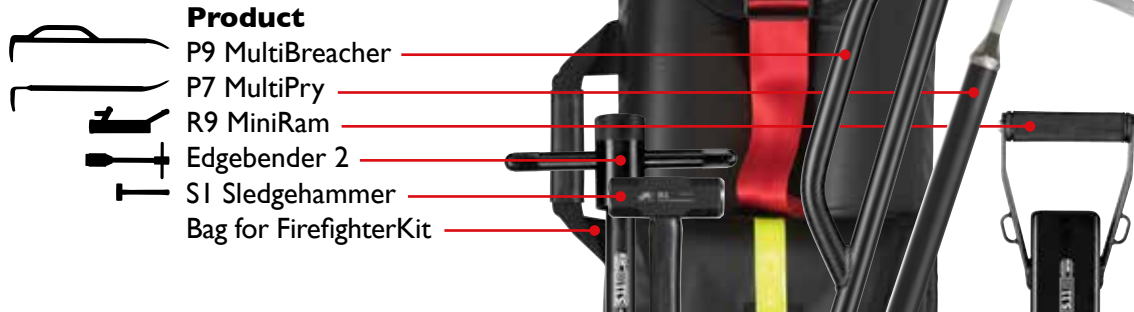

Product

P9 MultiBreacher

P7 MultiPry

R9 MiniRam

Edgebender 2

S1 Sledgehammer

Bag for FirefighterKit

The most complete and versatile Breaching Kit on the market for Fire Fighters

- The Firefighter Kit provides a complete solution tailored for professional firefighters, offering all the necessary tools to open both inward and outward-opening doors, regardless of the door's security rating.
- The Bag is designed with drainage features and is washable, making it easy to maintain and providing the ability to carry the bag while wearing air tanks.

• Prod Nr: MOE-032

• Weight: 23 kg

Light Breaching Kit

SWEDISH STEEL by SSAB 

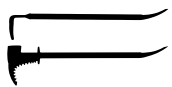

Product

P7 MultiPry

S3 MultiSledge

Bag for LightKit



The Light Kit is a versatile, lightweight solution designed for patrol cars, emergency services, and military units..

- The standard version includes our P7 MultiPry and S3 MultiSledge, which together provide the capability to breach both inward and outward-opening doors. This system is proven effective on certified security doors.
- The S3 MultiSledge also allows for the breaching of various types of windows, including laminated glass.
- Available in Dark Grey or Ranger Green

• Prod Nr: MOE-002-RG Light Breaching Kit – ranger green

• Prod Nr: MOE-002-DG Light Breaching Kit – dark grey

• Weight: 6.7 kg



P9 MultiBreacher

PATENT PENDING

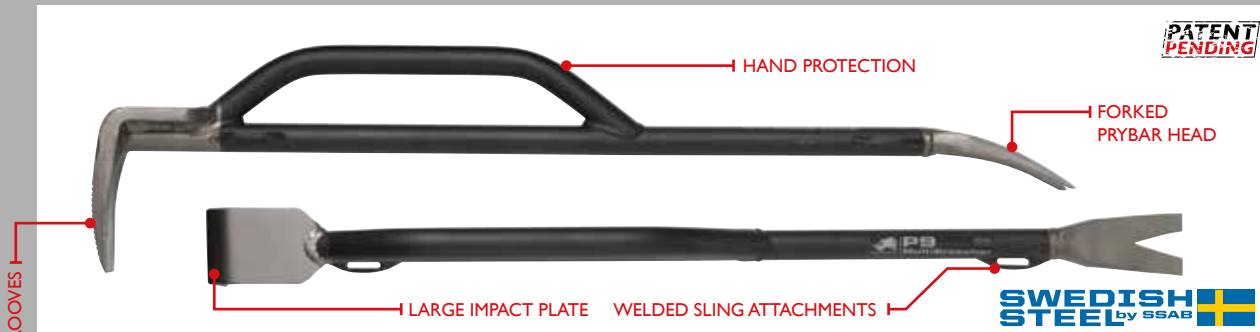

- A powerful, durable breaching tool made from Swedish steel. Designed for optimal performance on modern security doors, whether inward or outward opening.

• Prod Nr: MOE-062 • Length: 810 mm • Weight: 3.8 kg

PRODUCT INFORMATION



The design of the head together with our unique techniques gives you up to 1.5 ton's of continual pressure to the door.



The combination of MultiBreacher and MultiPry represents a unique opportunity to open the most impenetrable doors that normally requires hydraulic tools to open.



The head has a unique serrated wedge shaped with milled grooves, and provides the tool extreme case displacement and zero slippage.



The MiniRam gives the MultiBreacher the required power to separate the door from the frame.



EdgeBender 2



- This security plate/edge bypass tool has revolutionized the ability to open outward going metal and security doors in a reliable way.
- Without this tool there is a substantial risk that forcing the door will be completely unsuccessful. This is especially the case for niche mounted doors.

• Prod Nr: MOE-072 • Length: 435 mm • Weight: 3.1 kg

Information



With the EdgeBender you can quickly and quietly clamp the plate and simply bend it out of the way to gain access to the critical area near the bolt. The EdgeBender greatly reduces exposure time when dealing with security plates, especially in narrow hallways.

BREACHING TOOLS

P7 MultiPry



PATENT PENDING



• A lightweight, durable breaching tool made from Swedish steel. The unique design making it ideal for both inward and outward-going doors. The head and length are slightly more compact than the P9 MultiBreacher which makes it easier to carry.

• Prod Nr: MOE-014 • Length: 700 mm • Weight: 2.3 kg

Information



The MultiSledge give the MultiPry the needed power to open outward opening wood, metal and security doors.



You can't open up everything with a Ram. The combination of MultiPry and MultiSledge gains entry to inward opening doors in a few seconds.

The head has a unique serrated wedge shaped with milled grooves and provides the tool with extreme case displacement and zero slippage



The 2 point sling is an option for safe carriage and quick release of the tools.



2 point Sling,
• Prod Nr: MOE-077



S3 MultiSledge



- The MultiSledge™ is a unique multi functional tool. As four tools in one, it can be utilized as a Sledge hammer, Ram, prybar and break n' rake.
- With the break n' rake feature, it offers the operator the ability to shatter different types of windows including laminated and security/privacy glass and up to 1" thick laminate security glass. The head is a unique shape which allows for fast window entry and drapery and curtain rod removal.
- The prybar end is used in conjunction with the MultiPry tool to assist in the opening of reinforced inward opening doors.

• Prod Nr: MOE-008 • Length: 700 mm • Weight: 3.4 kg

Information



The sharp spike and optimal weight allows the operator the ability to shatter different types of windows including laminated and security glass often found on buildings, train etc. The head's unique shape allows for fast window entry and drapery and curtain rod removal when necessary.

The MultiSledge can be used as a conventional sledge hammer in conjunction with the MultiPry for entry through outward opening doors.



In small confined space, it is difficult to work with a sledge hammer. With MultiSledge it's not a problem because of the two striking faces and therefore it can also be used as a Ram.





R9 MiniRam



- The design of the MiniRam is unique in many ways. A new ergonomic technique designed to work with the Ram, creates a maximum striking force whilst retaining complete flexibility of use.
- The optimal weight and balance of the MiniRam offers both a traditional ram for forcing inward opening doors and combines as a striking tool for the MultiBreacher.
- The tool is designed to be able to be used at shoulder height without the weight of traditional rams. The striking head is convex formed like a hammer head.

• Prod Nr: MOE-007 • Length: 440 mm • Weight: 9.7 kg

Information



The MiniRam gives the Multibreacher the needed power to separate the door from the frame.

Ergonomical way to work with the tool

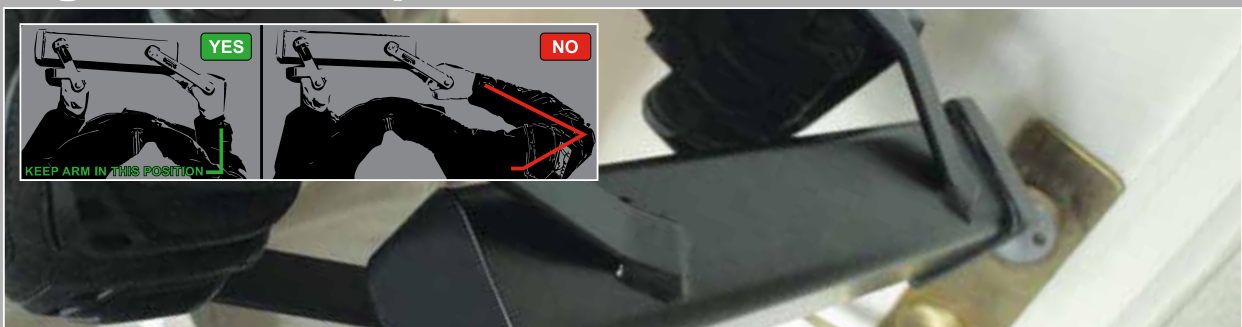

The reason why we get more power out of our MiniRam compared to other compatible Rams on the market are:

- Equal weight distribution across both handles means that you can use both arms for maximum effect. Traditional rams don't have equal weight distribution.
- The design of the MiniRam allows operators to work with the core strength instead of arms.

R15 MediumRam



- The MediumRam is designed with the same concept as our other rams. It is designed for one or two operators. The balance of the tool is centrally located between the handles, which means that all of the energy can be concentrated on striking instead of managing and maintaining balance of the tool.
- Similar to our other Rams, the Middle Ram has a convex head, which means that full power is guaranteed.
- The MediumRam is equipped with a safety hand protection.

• Prod Nr: MOE-071 • Length: 720 mm • Weight: 15.5 kg

R23 HeavyRam

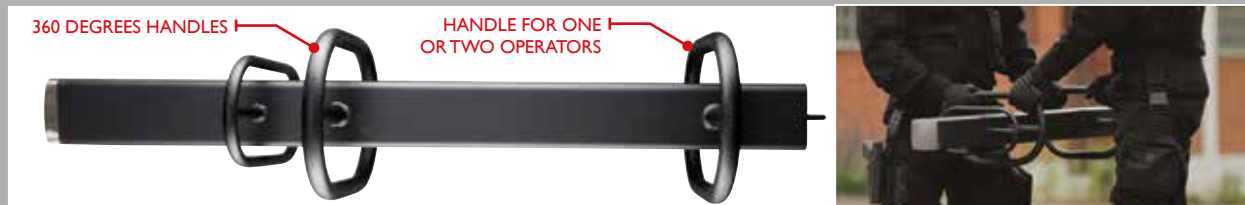

- This is our most powerful striking tool that is used for rapid entry through inward opening wooden doors and some metal doors. The HeavyRam weighs 23 kg and is designed for one, two or three operators.
- The HeavyRam has been carefully tested to ensure the weight of the Ram delivers maximum impact energy. Unlike other tools on the market it is designed to have the balance centered between the handles, which ensures Maximum efficiency and ensures proper balance and less strain on the operator.
- The 360 (degrees) handles are designed to offer the ability for the operator(s) to strike the low, middle or high point of the door dependant on where the locking point is located.
- As with all of our Rams, the striking head is formed like a hammerhead i.e. the head is convex. This means that unlike other striking tools the blow does not need to be perpendicular to give the maximum effect.

• Prod Nr: MOE-015 • Length: 1050 mm • Weight: 23 kg

Bolt Cutter 600mm



- Alloy steel blade, available to adjust jaw edge by adjusting bolt Drop-forged adapter. Cutting ability <HRC40.
- Confirm to GGG-C-740d Type II Class 3&4 Standard.

• Prod Nr: MOE-021 • Length: 24" (610mm)
 • Capacity: 10mm HRC15 or 6mm HRC40 • Weight: 2.4 kg

SI SledgeHammer



• Prod Nr: MOE-016
 • Length: 364 mm • Weight: 1.5 kg

SI Holder



• Prod Nr: MOE-024
 • Holder for SI with molle system.



Made by
Telesteps Sweden



SET Tactical Ladder

SET Tactical ladder is the first telescopic ladder in the world where 3 people can use the ladder at the same time. It is the 2nd generation with the revolutionary triangular tube design. This makes the ladder stronger and more torsionally rigid than ever before.

SET Tactical Ladder is certified according to the European norm EN 1147, specifically designed for tactical units - and rescue workers, which is one of the hardest certifications to obtain for a telescopic ladder. This means it can handle loads up to **500 kg or 3 people**.

- Triangular tube design
- Angled rubber feet and steps for better stability and maximum safety
- Simple to transport
- Simple & safe unlocking
- Made of high quality anodised aluminium with glass fibre reinforced plastic fittings
- Compact, easy to carry
- Light but strong

2 VERSIONS

	SET Tactical Ladder 3,5 m	SET Tactical Ladder 4,1 m
Number of steps	11	13
Length maximum	3,5 m	4,1 m
Length minimum	1,12 m	1,17 m
Width	0,47 m	0,47 m
Weight	15 kg	19,2 kg
Prod Nr	MOE-031	MOE-009



The first telescopic ladder in the world where 3 people can use the ladder at the same time or 500 kg load.



Strong and rigid for maximum stability and safety. Can be connect side by side as a tactical double ladder.



Telescopic function for easy carry and simple transport.



Velcro connecting straps transform solution from single to double ladder.



The ladder height is your choice.



Backpack Frame



• Prod Nr: MOE-013



Quick extension of the ladder without removing the Back Pack.



Adjustable feet for Tactical Ladders



• Prod Nr: MOE-134

With this feature you can use the ladder on a sloping/uneven ground or on a surface with level differences. This option does not affect the max load of 500kg.

Simply press the locking mechanism with your feet for quick and seamless adjustment up to 220mm.

Break'n Rake Standard and Extended

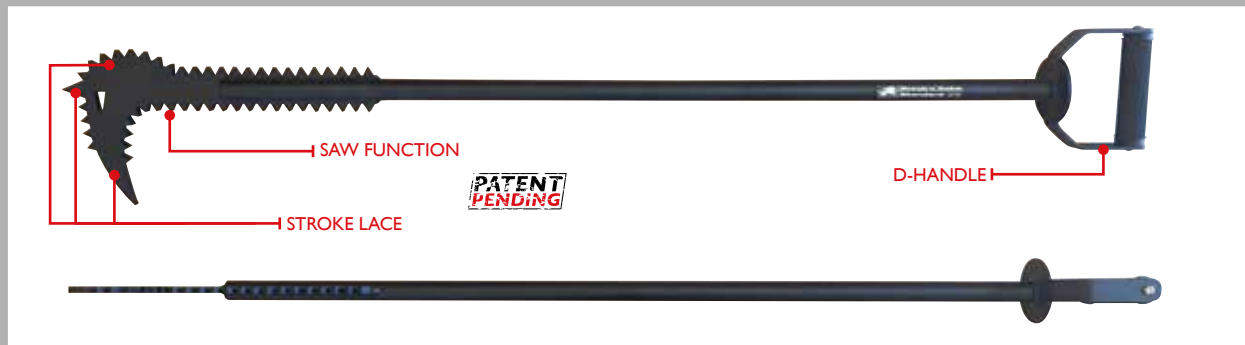

- The Gryphon Break'n Rake is made for breaching both traditional windows and laminated safety glass.
- The special design of the tool head allows the tool to easily penetrate different types of glass. Once penetration of the glass is achieved, the elongated teeth and the D-handle with rubber grip handle allows the operator to create openings in laminated security glass quickly and efficiently.
- Both standard and Extended length Break'n Rakes are available.
- The Extended Break'n Rake offers greater reach, offering enhanced cover and protection for the operator.

• Prod Nr: MOE-069	• Length: 1265 mm	• Weight: 3.75 kg
• Prod Nr: MOE-068	• Length: 1720 mm	• Weight: 4.55 kg

Break'n Rake Compact

NEW



SET QuickLock
Quick and easy connection between the different tools.

- Prod Nr: MOE-070
- Length each part: 730 + 670 mm
- Total Length: 1350 mm
- Weight: 4.5 kg



Divisible tool for easy carrying.



Penetrates all types of glass.



Holster for Break'n Rake Compact

- Molle function
- Prod Nr: MOE-022

Car Rake



- The Car Rake is designed to take control over modern vehicles. Its sharp teeth and tempered spikes ensure quick penetration of glass. Additionally, the built-in belt cutter makes this tool indispensable in emergency situations. Can safely be stored inside your vehicle together with the Car Rake Pocket.
- Provides several options:
 - Breach both hardened and laminated car windows.
Due to the design, the laminated side windows can be removed in a few seconds.
 - Puncture tires
 - Cut seatbelts

• Prod Nr: MOE-030 • Length: 495 mm • Weight: 1.6 kg

Car Rake Pocket



- Molle and velcro attachment.

• Prod Nr: MOE-018

Information

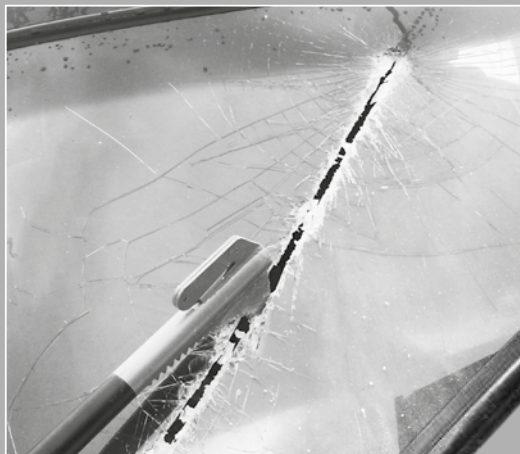

The full tempered spike goes easily through different type of vehicle glass, even laminated glass.



The laminated car window is gone in a few seconds.

MIEC2 TRAINING DOOR



The only training door in **THE WORLD**

that allows
realistic
**MECHANICAL
& HYDRAULIC**
breaching training
on outward &
inward going
doors!

**LEARN MORE ABOUT MEC2
ON THE NEXT PAGE**

**PATENT
PENDING**

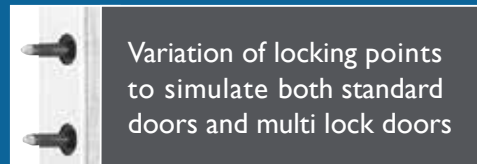

- Prod Nr: MOE-034
- Width: 1175 mm • Depth: 200 mm
- Height: 2228 mm • Weight: 280 kg

- MEC2 training door has a unique design and is the only training door in the world that allows realistic mechanical & hydraulic breaching training for out & inward going doors.
- A frame that authentically replicates real doors in real frames, giving operators the skill and confidence to be effective on time every time.
- Whether inward or outward going doors, the SET training door is compatible with the full range of mechanical and hydraulic entry tools.
- Multi point locking mechanisms can be readily, faithfully and economically duplicated using sacrificial steel pins or wooden pegs.
- Modular construction enables easy transportation and rapid assembly, if required.
- Can be mounted in a wall, container or used as a stand alone module.



Prying out swing door



Prying in swing doors



Ram training



Wood Shims at top and bottom for Multi lock training



Steel pins provide the same resistance as real locks



Exchangeable frame (Case Edges)



Different types of hydraulic entry tools can be used on the MEC2 Training Door. For more info about training program contact SET Breaching.



To use a Door Raider on the Training Door a platform is needed. (Not necessary when the training door is installed in a container or building)

Prod Nr: MOE-049 (Number 3)



Exchangeable Door Jamb Edges



Adjustable resistance

MEC2

MANUALS FOR MEC2 TRAINING DOOR



User instructions and QR codes to online manuals.

SPARE PARTS FOR MEC2 TRAINING DOOR

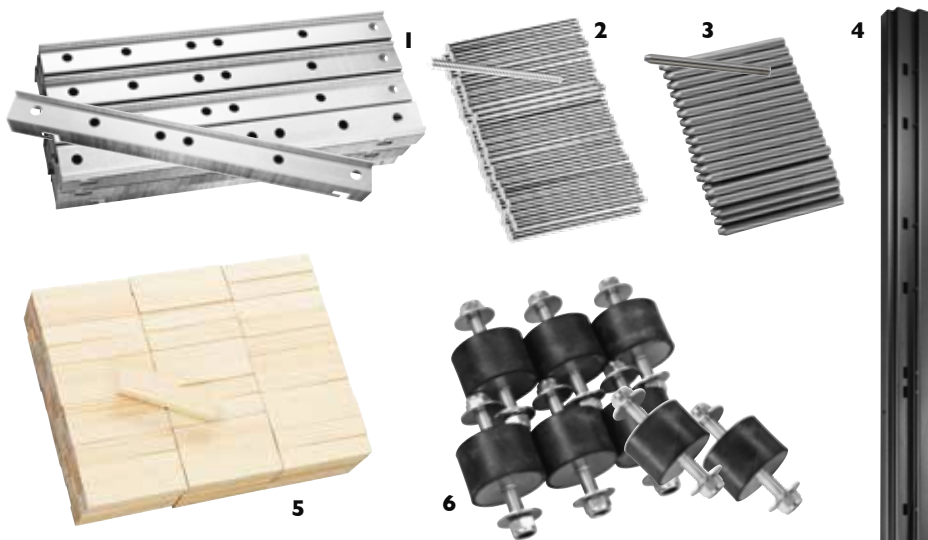

- | | | |
|---|---|------------------|
| 1 | Replacement DoorjambEdges (24 pcs) | Prod Nr: MOE-047 |
| 2 | Steel Pins for Hydraulic Breaching (50 pcs) | Prod Nr: MOE-041 |
| 3 | Steel Pins (50 pcs) | Prod Nr: MOE-039 |
| 4 | Replacement Case Edges (1 pcs) | Prod Nr: MOE-044 |
| 5 | Wood Shims (200 pcs) | Prod Nr: MOE-040 |
| 6 | Rubber Cushion Training Door (8 pcs) | Prod Nr: MOE-035 |

MUT4 TRAINING DOOR

INWARD BREACHING



**Pushing charge
on head locks**

**Cutting charge
on head locks**

PRODUCT INFORMATION

MUT4

Product Nr: MOE-036

The new MUT4 is a multifunctional training door developed for kill houses, shooting ranges and other training facilities where different breaching methods are required.

The MUT4 comes with a Stand Alone Frame but can also be installed in a training structure.

Measurements

Width: 1070 mm Depth: 80 mm
Height: 2190 mm Weight: 160 kg

Optional Accessories:

MOE-148 Hardox Plate for MUT4

This provides the opportunity to practice explosive breaching with pushing charges. Since the plate is used over and over again, the training becomes effective and affordable.



MUT4 TRAINING DOOR

OUTWARD BREACHING

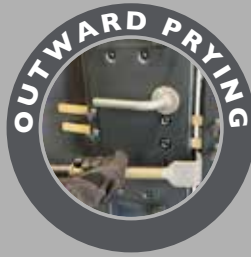

Moving cassette system for optimal simulation of a real door breaching

SPARE PARTS



Wood Sticks

100 pcs
Product Nr: MOE-051



Steel Rods

10pcs
Product Nr: MOE-052



Wood Boards Center

10pcs (including Head Lock Label)
Product Nr: MOE-059

EXP2 TRAINING DOOR



3 different way to train with explosive charges

1. Cutting charge on wood board with wood frame behind (2X2 inch wood)
2. Tamping charges to simulate steel/security doors. Plate thickness 1,5 mm
3. Pushing charge on 8 mm Hardox plate for easy and very fast repetition without any needs of changing spare parts. Max. 20g explosives when using this option.

- Prod Nr: MOE-055 • Width: 1296 mm
- Depth: 200 mm • Height: 2232 mm
- Weight: 155 kg including the stand

SPARE PARTS FOR EXP2 TRAINING DOOR



- EXP 2 Training Door is specially designed for explosive breaching training with cutting & pushing charges.

The door simulate full length cutting & pushing charges on wood, plastic & steel doors.

Field tested by military units with 250 gram TNT cutting charges.

Opportunity to use Rotary cutting machines, chain saw and thermal cutting equipment as well.



Wood Block at top and bottom to protect the frame from the explosive charge.



- 1 Wood Blocks (25pc) Prod Nr: MOE-056
- 2 Wood Boards (10pc) Prod Nr: MOE-057
- 3 Metal Sheet (5 pcs) Prod Nr: MOE-058
- 4 Hardox Metal Sheet (1 pc) Prod Nr: MOE-061

SET GLASS TRAINING FRAME

Manual Break 'n Rake • Chain Saw cutting • Explosive cutting • Sniper Training



• SET not only offer the best tools on the market for glass entry, we also offer a unique training frame for Break 'n Rake training.

• Occasionally, entry through a window may be the only way to get into a property. But this is also one of the most dangerous ways to get in because of all the pieces of glass stuck in the window frame after the initial opening has been created.

• Prod Nr MOE-037 • Width: 1091 mm
• Depth: 200 mm • Height: 2229 mm

Spare parts

- Plastic Replacement Sheets (MOE-038)
- Wood Mounting Blocks (MOE-048)
- Laminated Glass Replacement Sheets 5pcs pcs (MOE-054)

Up to 3 layers of glass can be mounted

- Plastic sheets (best and cheapest training option)
- Laminated glass



Our glass tools are the only tools on the market that clears away all the glass fragments quickly and efficiently, but its important to have the right technique and training.



Easy replacement of glass or plastic sheets.



Different layers of glass or plastic sheets can be mounted to simulate various types of windows.



Individual pressure adjustment.



The wood frame can be used many times before it needs to be replaced.

Door & Window Frame



- Heavy Duty Door & Window Mounting Frame for installation of real doors and windows
- Mechanical Breaching
- Hydraulic Breaching
- Explosive Breaching
- The frame can be used as a free standing module or mounted direct into a wall or container.
- Maximum doorsize 2150x1200mm.

- Prod Nr: MOE-045
- Width: 1666 mm • Depth: 200 mm
- Height: 2260 mm • Weight: 245 kg

**PATENT
PENDING**

Fastening Brackets for windows is an option for the door and window frame. Prod Nr: MOE-046



The wood frame gives a strong, realistic and easy mounting of the doors.



The Mounting Frame allows inward and outward opening door breaching.



With ball bearings on the frame, the width can easily be adjusted for different size of doors.



The Door Mounting Frame can be installed in many different ways. Here is an example when a military unit do explosive training with the Door Mounting Frame installed in a training house.

TRAINING EQUIPMENT



TRAINING EQUIPMENT

CUSTOMIZED FOR MILITARY – LAW ENFORCEMENT – FIRE – AGENCY

BREACHING RIG / TOWERS

MADE BY SET



The standard setup for SET Breaching Rig

- MEC2 Training Door
- MUT4 Training Door
- Door & Window Frame
- Glass Training Frame



The standard setup of the Rig enables a variety of ways to practice breaching.

- Mechanical Breaching
- Glass Breaching
- Shotgun Breaching
- Hydraulic Breaching
- Explosive Breaching
- Thermal Breaching
- Rotary Cutting machines
- Chain Saw Breaching



SET BREACHING

COMPLETE SOLUTION FOR A WIDE RANGE OF DYNAMIC BREACH TRAINING

TRAINING EQUIPMENT

DIFFERENT OPTIONS FOR THE BREACHING RIG



MEC2
TRAINING DOOR
More info on page 26



MUT4
TRAINING DOOR
More info on page 30



EXP2
TRAINING DOOR
More info on page 32



GLASS TRAINING FRAME
More info on page 33

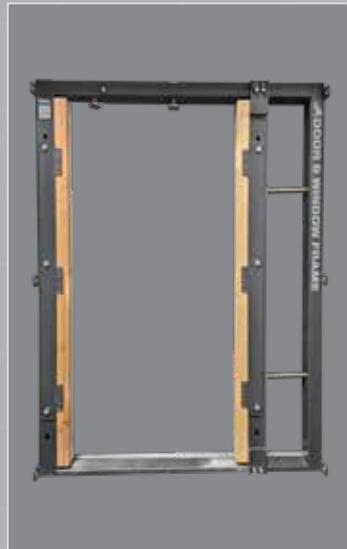

DOOR & WINDOW FRAME
More info on page 34

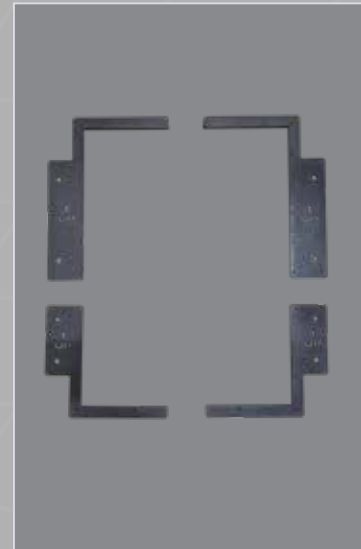

DOOR & WINDOW FRAME
Fastening Brackets for windows is an option for the door and window frame. Prod Nr: MOE-046

ACCESSORIES



Different mounting solutions to optimize training scenarios



Storage for spare parts



Cover for weather protection



Training instructions by using QR-codes

WE DO NOT JUST SELL BREACHING TOOLS -



WE OFFER YOU KNOWLEDGE AND EXPERIENCE





BREACHING

MEMBER OF SKYLOTEC

Skylotec Nordic AB / SET Breaching AB
Kontorsvägen 6, S-24643 Löddeköpinge, Sweden

info@skylotec.se / info@setbreaching.com